

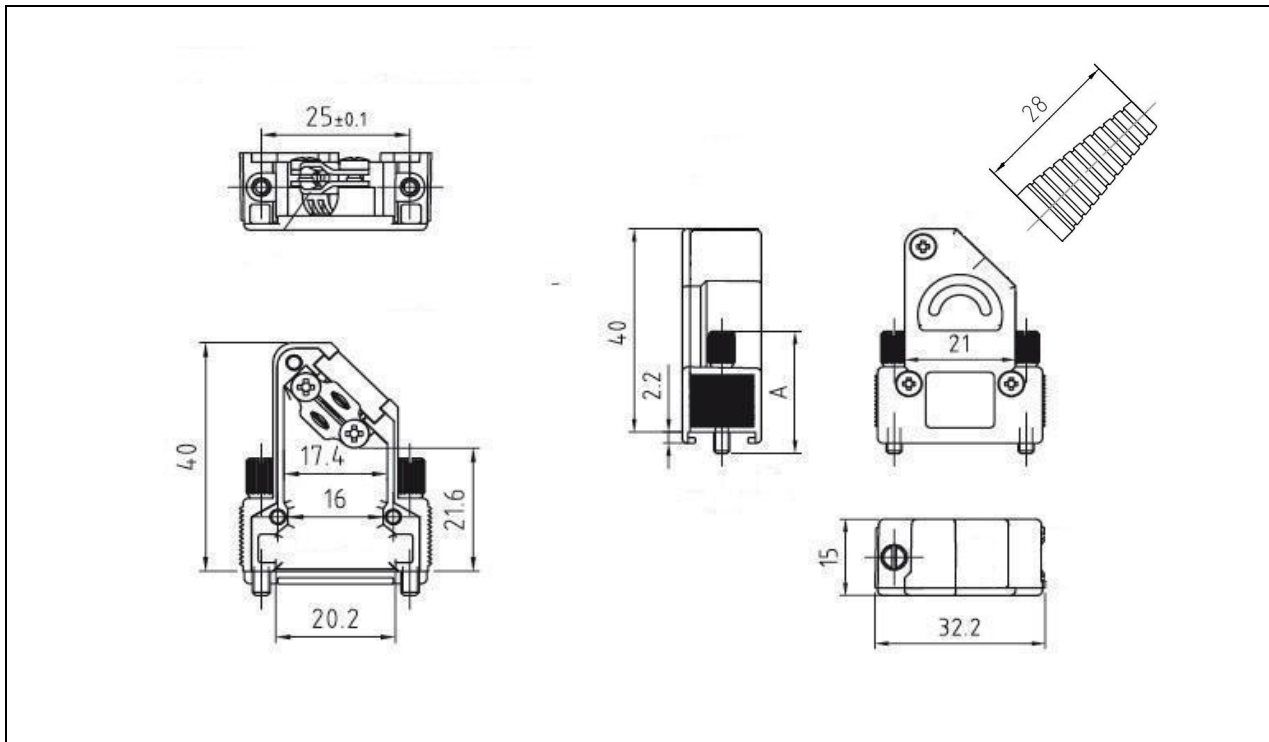







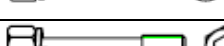

AIRconnect – Sub-D Gehäuse

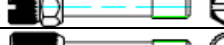

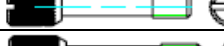
Bezeichnung Sub-D Gehäuse, 9-polig

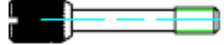
Beschreibung Störstrahlsicheres Metallgehäuse mit Anschluss-technik für Crimpflansch oder Kabelschelle
Schräger Kabelausgang
Gehäuselänge: 40mm
Vergrößerter Innenraum zur einfacheren Verdrahtung
Deckelschrauben unverlierbar vormontiert

Artikelnummer	Typ	Verriegelungsschraube			Gewicht [g]
		A [mm]	Gewinde		
52 09 133	DS-09-133	20,7	M3		41
52 09 143	DS-09-143	20,7	4UNC40		41
					
					
					
					
					
					
					
					
					

07. Mai 2013 Technische Änderungen vorbehalten